

Library L.M.A.L.

0313
17
11

TECHNICAL NOTES

NATIONAL ADVISORY COMMITTEE FOR AERONAUTICS

No. 624

PERFORMANCE CHARACTERISTICS OF VENTURI TUBES USED IN
AIRCRAFT FOR OPERATING AIR-DRIVEN GYROSCOPIC INSTRUMENTS

By Harcourt Sontag and Daniel P. Johnson
National Bureau of Standards

Washington
November 1937



NATIONAL ADVISORY COMMITTEE FOR AERONAUTICS

TECHNICAL NOTE NO. 624

PERFORMANCE CHARACTERISTICS OF VENTURI TUBES USED IN
AIRCRAFT FOR OPERATING AIR-DRIVEN GYROSCOPIC INSTRUMENTS

By Harcourt Sontag and Daniel P. Johnson

SUMMARY

Wind-tunnel and flight tests were made to determine the performance characteristics of two designs of commercially available venturi tubes used in airplanes to operate air-driven gyroscopic instruments.

For constant values of the ratio of suction to atmospheric pressure, the air flow is approximately a linear function, independent of altitude for a double venturi tube, of the product of the indicated air speed and the square root of the ratio of standard air pressure to the atmospheric pressure. Consequently, data obtained at sea level may be used to make approximate predictions of performance at higher altitudes. There is some indication that this may be also done for single venturi tubes.

For a given installation in which an air-driven instrument is connected through tubing with a venturi tube, the volume rate of induced air flow is approximately proportional to the product of indicated air speed and the square root of the ratio of standard to ambient air pressure. The efficiency of such a system at a given altitude is constant.

Rather large variations in suction and efficiency were found for individual tubes of the same design. Cylindrical fairing on the external surface resulted in a reduction of both drag and suction but little change in efficiency. The effect of large angles of pitch or yaw was small. Measurements were also made of the pressure along the wall of the tube.

INTRODUCTION

Venturi tubes are used in many airplanes to operate

air-driven gyroscopic instruments. The operating efficiency of venturi tubes is known to be low in comparison with that of vacuum pumps of the displacement type but their mechanical simplicity and low first cost have furthered their continued use. Although some data on the performance of venturi tubes as vacuum pumps have been published (references 1, 2, and 3), it was considered desirable to undertake an experimental study of the performance characteristics of venturi tubes now being used. As part of this study, two types of commercially available venturi tubes were subjected to wind-tunnel and flight tests. The investigation was made with the cooperation and financial support of the National Advisory Committee for Aeronautics.

APPARATUS AND TESTS

The Venturi Tubes

Three single and three double venturi tubes were tested. The single tubes were made by the Pioneer Instrument Company for use in operating turn indicators and were designated P1, P2, and P3. The double venturi tubes, designated S4, S5, and S6, were made by the Sperry Gyroscope Company and are of the type commonly used to operate directional gyros and gyroscopic horizons. During the tests, tube S6 was provided with a cylindrical fairing and was then designated S7.

A diagram and a photograph of the single tube are shown in figures 1 and 2, respectively. The air flows from the instrument case through connecting tubing to the venturi inlet and then through holes drilled in the venturi base to an annular chamber surrounding the throat of the tube. It then discharges through a cylindrical opening into the air stream.

The double tube (figs. 3 and 4) has a large and a small venturi tube coaxially mounted with the trailing edge of the small tube well forward of the plane of the throat of the larger one. Air from the venturi inlet passes through holes drilled in the base of the venturi tube and discharges from an annular chamber in the throat of the smaller unit. The external surface of the smaller tube is cylindrical. Both the leading and trailing edges of the larger one are flared.

Tests

The tubes were tested in the 3-foot wind tunnel of the National Bureau of Standards at several different air speeds between 45 and 135 miles per hour to determine:

1. The flow-suction characteristics and drag of three venturi tubes of each type.
2. The effect of cylindrically fairing the external surface of the larger unit of a double venturi tube.
3. The effects of pitch and yaw on the suction characteristics of a double venturi tube.
4. The pressure gradient obtaining along the internal surface of the larger unit of a double venturi tube.

With the cooperation of the Flight Test Section at the Naval Air Station, Anacostia, D.C., additional data were obtained in flight on the flow-suction characteristics of one of each type of venturi tube (P3 and P6). Data were obtained at altitudes up to about 15,000 feet and at indicated air speeds varying from 70 to 160 miles per hour.

Each venturi tube was mounted in the wind tunnel on a tubular support (fig. 5) attached to the mechanism used for measuring the drag. Air entered the line leading to the venturi tube from a large wall-plate opening in the side of the wind tunnel. It then passed through a portion of the line containing the flowmeter and a manually operated flow-regulating valve to the tubular support, and thence into the venturi inlet. The pressure differences necessary to determine the air speed in the wind tunnel, the air flow in the line connected with the venturi tube, and the suction developed by the tube were measured by U-tube manometers as shown in figure 5. The tests were made with atmospheric pressures varying from 740 to 760 millimeters of mercury and at air temperatures varying from 25° to 35° C.

A fixed orifice was used as a flowmeter for measuring the rate of flow of air induced by the venturi tubes. The flowmeter was calibrated against a displacement-type gas meter at several air densities, the calibration showing

the maximum uncertainty in the measurement of the rate of flow to be less than 2 percent of the indicated rate.

In the flight tests the venturi tubes were mounted on a bracket suspended between one set of interplane struts on a biplane, in a position well outside the slipstream of the propeller. The air flowed from the flowmeter installed in the cockpit of the airplane through lines of heavy-walled rubber tubing to the venturi tubes. Aneroid gages were used to measure the suction developed by the tubes and the differential pressure across the flowmeter orifice.

When used to operate gyroscopic instruments, the venturi tube is usually mounted on the airplane in the slipstream of the propeller where it is subjected to the maximum velocity of the air. It is known that the average slipstream velocity may exceed the air speed of an airplane by as much as 60 percent (reference 4). The effect of the fluctuations in the velocity of the slipstream, due to the action of the propeller, on the performance of the tubes was not investigated.

RESULTS

Wind-Tunnel Tests

Unless otherwise stated, the suction given in the results refer to the difference between the static pressure in the wind tunnel and the pressure obtaining at the inlet of the venturi tube, due allowance having been made for the pressure drop between the point in the line at which the suction was measured and the venturi tube.

Air flow and suction at sea level.— The results of the wind-tunnel test of venturi tube S6 are shown in figure 6. In the figure the observed suction is plotted against the rate of flow of air obtained by varying the setting of the manually operated flow-regulating valve while the indicated air speed was held constant. From these curves and similar ones for tube P3, the curves of figures 7 and 8 were prepared. The abscissa in the latter figures is the indicated air speed V_i multiplied by the square root of the ratio of the standard sea-level pressure p_s (29.92 inches of mercury) to the static pressure p_a in the wind tunnel. Each diagonal line is for a constant value of the ratio of the suction S to the static pressure p_a .

The variation in the performance characteristics of the three single venturi tubes is shown in figure 9 for the condition of no flow of air in the line (curves A), and for a line of flow of 1 cubic foot per minute (curves B) at the ambient atmospheric pressure. Similar data for the three double venturi tubes and for the cylindrically faired tube S7, are shown in figure 10 with the exception that curves B are for a flow of 2 cubic feet per minute measured at the ambient atmospheric pressure. The data show marked variations in the performance of venturi tubes of the same design which amounted to about 8 percent in the air speed required to obtain a given suction.

An examination of the venturi tubes indicated that the differences in performance were due, not to variations in workmanship which would be evident in a casual inspection, but to small variations in the dimensions of the tubes, particularly in the vicinity of the throat and in the surface roughness of the diverging cones. The decrease in the ratio of suction to impact pressure at high air speeds as a result of roughness or dirt in the throat of venturi tubes, has been noted previously (references 5 and 6).

Drag.— Within the range and accuracy of the tests, the drag of the venturi tubes was proportional to the impact pressure q , independent of the air flow through the venturi inlet, that is,

$$D = B_d q \quad (1)$$

in which D is the drag, and B_d is a constant which may be called the "drag coefficient." The values of B_d for the venturi tubes tested when D is in pounds and q is in pounds per square foot, are given in table I, together with the approximate drag in pounds at 100 miles per hour.

TABLE I

Venturi tube	B_d (sq. ft.)	Drag at 100 m.p.h. (lb.)
P1	1.8×10^{-2}	0.47
P2	1.9	.49
P3	1.7	.44
S4	7.46	1.94
S5	7.54	1.96
S6	7.62	1.98
S7	5.2	1.35

Pressure drop in venturi passages.— The magnitude of the resistance of the passages in the base of the venturi tubes to the flow of air was determined by measuring the pressure required at the inlet to maintain a given rate of flow with the venturi tube stationary relative to the surrounding air. This pressure Δp , varied as the square of the rate of flow of air F at the conditions of pressure and temperature obtaining during the tests in accordance with the following equation:

$$\Delta p = K \frac{\rho}{\rho_s} F^2 \quad (2)$$

where ρ is the average density of the air in the passages, ρ_s is the standard density at sea level, and K is a constant.

The values of the constant K for the venturi tubes tested, when Δp is in inches of mercury, and F is in cubic feet per minute, are given in table II. This constant is numerically equal to the pressure drop in inches of mercury for a flow of 1 cubic foot per minute at standard density.

TABLE II

Values of the constant K in equation (2)						
Venturi tube	P1	P2	P3	S4	S5	S6
K	0.154	0.153	0.146	0.093	0.098	0.112

Pitch and yaw.— The effects of pitch and of yaw on the suction characteristics of double tube S6 at an air speed of about 96 miles per hour are shown in figures 11 and 12, respectively. The suction is here plotted against the pitch (or yaw) angle for three conditions: no flow of air, flow of 1 cubic foot per minute, and flow of 2 cubic feet per minute referred to the ambient pressure. [In figure 11 a positive pitch refers to an upward tilt of the leading edge of a tube mounted initially on a horizontal surface. Yaw refers to a rotation of the instrument about an axis perpendicular to the mounting plane.] The form of these curves bears some resemblance to that of curves (reference 7) relating the variation of pitot-static differential pressure with yaw. In the light of these results and the tests by Draper and Spilhaus (reference 3), great accu-

racy in aligning the venturi tube with the air stream appears to be unnecessary.

Pressure distribution along venturi tube.— The results of the test made to determine the pressure distribution obtaining along the internal surface of the larger unit of double venturi tube S4, are shown in figure 13 for air speeds of 45 and 135 miles per hour and for the condition of zero induced air flow. The pressure distribution is independent of the air speed at all points along the length of the tube except in the vicinity of the throat of the larger unit, where the pressure difference is greater at the higher air speed. The over-all loss of head is of the order of the impact pressure.

The pressures obtaining along the internal surface of the larger unit of tube S4 during the foregoing test were not appreciably affected by the flow of air through the line except in the immediate vicinity of the throat. Figure 14 shows the effect of flow on the suction at three points for an air speed of 135 miles per hour. Curve L shows the suction at the throat of the larger unit; curve S, the suction at the throat of the smaller unit; and curve F, the suction at the inlet on the base of the venturi tube. It is seen that the suction at the throat of the larger unit falls off slightly with increase in flow while those at the throat of the smaller unit and at the inlet fall off much more rapidly; in fact, the suction at the throat of the larger unit is greater than that at the throat of the smaller one for flows in excess of 2.6 cubic feet per minute.

Performance of modified tube.— It was found that cylindrical fairing on the external surface of double venturi tube S6, called S7 after fairing, reduced the drag by about 25 percent, and reduced the power developed when there was air flow by 25 to 30 percent. The suction for no induced air flow and for a flow of 2 cubic feet per minute, are shown as functions of impact pressure in figure 10. The decrease in suction compared to that of the unfaired tube (S6) is evident. It may be concluded that the operating efficiency is not substantially increased by cylindrically fairing the tube.

Flight Tests

The results of flight tests on tube S6 are shown in figure 15. The points shown in the figure were taken from curves, similar to those of figure 6, in which air flow at

the venturi inlet was plotted against the ratio of suction S to atmospheric pressure p_a , for a given altitude and for a given air speed. The dotted lines are the results of wind-tunnel tests.

An inspection of figure 15 shows that the curves for constant S/p_a move slightly to the right with increase in altitude. However, this manner of presenting the data gives curves which are more nearly independent of altitude than any of the other ways of presentation which were tried. For many purposes the data at sea level so plotted can be taken as invariant with altitude without introducing serious error.

Figure 16 indicates that for a given induced air flow a single curve of S/p_a against q/p_a , or its equivalent, $V_i^2 p_s/p_a$, represents the results obtained at all altitudes. Here q is the dynamic pressure, p_s and p_a are, respectively, the standard sea-level air pressure and the static pressure of the air surrounding the venturi tube, and V_i is the indicated air speed. The agreement is within the accuracy of the tests. Curve A is for single tube P3 and curves B and C for double tube S6. In the upper part of curve B, where the values of the ratio q/p_a are the highest, the suction appears to approach as a limit a value in the neighborhood of $2/3$ the atmospheric pressure. This limit is considerably higher than that observed by Peters for a Bruhn double-throat venturi tube (reference 8).

The relation between the quantity $V_i \sqrt{\frac{p_s}{p_a}}$ and the volume rate of flow of air at the venturi inlet obtained in the flight tests, is shown in figure 17. During the tests the flow-regulating valves were kept at one setting, i.e., wide open - an operating condition that may be likened to one particular installation of air-driven instrument and connecting tubing. Within reasonable limits the points all fall on straight lines through the origin, showing the existence of a simple proportionality, independent of altitude, between $V_i \sqrt{\frac{p_s}{p_a}}$ and the volume rate of flow induced by a venturi tube through a fixed system of orifice and connecting tubing.

Flight-test data taken for the single venturi tube P3 are shown in curve A of figure 16, which shows the suction

developed with no induced air flow. In figure 17, curve A shows the volume air flow with the control valve wide open as a function of air speed times the square root of the pressure ratio. These data are in qualitative agreement with those for the double venturi tube in the extreme cases of no induced air flow and maximum air flow, and would indicate that the conclusions reached for the double venturi tube may be extended to the single tube. Complete flight-test data could not be obtained on tube P3 because of accidental damage to the tube. Flight data were obtained on tube P2, which yielded curves similar to those shown for tube P3.

A wind-tunnel test was made with tubes S6 and P2 mounted on a strut with the same bracket as was used in the flight test. Agreement between the flight test at sea level and the wind-tunnel test was good in the case of the tube S6. For tube P3 there was agreement in the suction developed with no induced flow, but the suction for a given flow in the flight test was much less than in the wind-tunnel test. The source of the discrepancy was not determined.

PERFORMANCE COEFFICIENTS AND EFFICIENCY

The principal operating properties of the venturi tube when used as a source of suction may be expressed in terms of coefficients computed from data obtained from tests. These properties are: a) the static suction S_0 developed with no induced air flow; b) the capacity in terms of the volume rate of flow of air; and c) the drag.

The suction coefficient B_s is defined by the relation

$$\frac{S_0}{2} = S_m = B_s q \quad (3)$$

where S_0 is the suction developed with no induced air flow, and q , the impact pressure. The suction coefficient is the equivalent of the expression "relative performance" used in reference 6. Alternatively,

$$\frac{S_0}{p_a} = 2B_s \frac{q}{p_a} \quad (3a)$$

where S_0/p_a and q/p_a are the coordinates of figure 16, A and B. It may be seen from this figure that B_s is nearly independent of altitude and air speed at air speeds between 75 and 150 miles per hour, and is a function of

$V_i \sqrt{\frac{p_s}{p_a}}$ or q/p_a at greater air speeds.

The flow coefficient B_f is defined as the ratio of the volume air flow F referred to the pressure obtaining at the inlet, to the true air speed V_t when the venturi tube is operated so that the suction is S_m , that is:

$$B_f = \frac{F}{V_t} \quad (4)$$

The proportionality between F and $V_i \sqrt{\frac{p_s}{p_a}}$ may be verified from figure 17. Since $V_i \sqrt{\frac{p_s}{p_a}}$ does not differ greatly from the true air speed, it follows that this coefficient is nearly independent of the air speed and altitude. It has the dimensions of area.

The drag coefficient B_d , defined previously in the section on results, is the ratio of the drag D to the impact pressure q . It also has the dimensions of area.

The power developed by a venturi tube is proportional to the product of suction and induced air flow. The data of figure 6 indicate that at a fixed air speed the maximum power is very nearly that developed when the tube is operated at a suction which is half that obtained with no induced flow; that is, when $S = S_m$. Piercy and Mines (reference 2) also call attention to this fact. Consequently, the maximum efficiency E_m may be expressed in terms of the suction, flow, and drag coefficients as follows:

$$E_m = \frac{S_m f}{D V_t} = \frac{B_s B_f}{B_d} \quad (5)$$

In a particular installation of venturi tube and gyroscopic instrument, for example, that represented by line H in figure 8, the efficiency is approximately the same at all air speeds at a given altitude. If an installation be so designed that the venturi tube operates at a suction about half that for no induced air flow at any given air speed, it will operate at very nearly the maximum efficien-

cy at all altitudes and air speeds. The efficiency will be less for installations operating at suction much above or below half the static suction.

The values of the coefficients and efficiencies of the 7 venturi tubes at sea level and at an air speed of 80 miles per hour, are listed in table III.

TABLE III

Performance Coefficients and Efficiencies of the
Venturi Tubes at Maximum Power Output

Venturi tube	B_s	B_f (sq. ft.)	B_d (sq. ft.)	$E(\text{max.})$ (percent)
P1	3.9	1.8×10^{-4}	1.8×10^{-2}	3.9
P2	3.6	1.8	1.9	3.4
P3	3.8	2.0	1.7	4.5
S4	6.9	2.6	7.5	2.4
S5	8.0	2.6	7.5	2.8
S6	7.8	2.8	7.6	2.9
S7 (faired)	6.7	2.3	5.2	3.0

The efficiency as given in the last column of table III is not directly comparable with that of the engine-driven vacuum pump since the efficiency of the latter is usually computed on the assumption that the mechanical pump receives its power directly from the engine of the airplane. On the other hand, the power required by the venturi tube is derived from the engine through the thrust developed by the propeller. Therefore the efficiencies given in the table should be multiplied by the efficiency factor of the propeller of the airplane before a direct comparison is made.

DISCUSSION

The ratio of impact pressure q to the atmospheric pressure p_a equals

$$\frac{q}{p_a} = \frac{1}{2} V_t^2 \frac{\rho_a}{p_a} \quad (6)$$

in which ρ_a is the ambient atmospheric density, and V_t the true air speed. But

$$\frac{\rho_a}{\rho_s} = \frac{p_s}{p_a} \frac{T_s}{T_a} \quad (7)$$

and

$$V_t^2 \frac{T_s}{T_a} = V_i^2 \frac{p_s}{p_a} \quad (8)$$

where ρ_s and p_s are the standard sea-level atmospheric density and pressure; T_s and T_a , the standard sea-level and ambient atmospheric temperatures in degrees absolute, respectively; and V_i , the indicated air speed. By substitution from equations (7) and (8) into equation (6) there results:

$$\frac{q}{p_a} = \frac{1}{2} \frac{\rho_s}{p_s} \frac{T_s}{T_a} V_t^2 = C \frac{T_s}{T_a} V_t^2 = C \frac{p_s}{p_a} V_i^2 \quad (9)$$

It should be noted that in equation (9) when $T_s = T_a$ or $p_s = p_a$, the ratio q/p_a is directly proportional to V_t^2 or V_i^2 , respectively.

Since the speed of sound is proportional to $\sqrt{\frac{T_a}{T_s}}$, the quantity $V_t \sqrt{\frac{T_s}{T_a}}$ is proportional to the ratio of the true air speed to the speed of sound. It follows then, by equation (9), that the abscissas of figures 7, 8, 15, 16, and 17 are proportional to the ratio of the true air speed to the speed of sound.

Comparison of altitude and sea-level data in figure 15 for the double venturi tube shows that the curves presented in figure 8 are approximately independent of altitude, or air density, within the air-speed range of the tests. Figure 17 shows further that for a given orifice in the line, the induced air flow is proportional to

$V_i \sqrt{\frac{p_s}{p_a}}$. This fact may be extended with reasonable accuracy to include the case of a gyroscopic instrument and tubing connected to the venturi tube.

The relation between volume air flow and suction for typical gyroscopic instruments, together with connecting tubing, was determined at the air pressure obtaining approximately at sea level and at that corresponding to a standard altitude of 20,000 feet. In figure 8 the line H represents sea-level data for a gyroscopic horizon with connecting tubing across which the pressure drop was about one-half that across the horizon. The line DG represents the sea-level data for a directional gyroscope and tubing across which the pressure drop was about one-fifth that across the instrument alone. Data obtained at the higher altitude fall below this line except at the higher values of $V_i \sqrt{\frac{p_s}{p_a}}$. The air flow and suction were measured at

the low pressure end of the tubing and were therefore identical with the induced air flow and suction at the suction inlet of the venturi tube.

As an example of a computation, assume an installation of a directional gyro and tubing having the performance given by line DG in figure 8 and operated by venturi tube S6, to determine the suction and air flow at an indicated air speed of 100 miles per hour at zero altitude and at 15,000 feet. At zero altitude:

$$V_i \sqrt{\frac{p_s}{p_a}} = 100 \text{ m.p.h.}$$

Flow (at intersection of 100 m.p.h. line and DG line) = 1.15 cu.ft./min.

$$S/p_a = 0.157 \quad \text{and} \quad S = 29.92 \times 0.157 = 4.7 \text{ inches of mercury.}$$

At 15,000 feet:

$$p_a \text{ at 15,000 ft.} = 16.88 \text{ inches of mercury.}$$

$$V_i \sqrt{\frac{p_s}{p_a}} = 100 \sqrt{\frac{29.92}{16.88}} = 133 \text{ m.p.h.}$$

Flow (at intersection of 133 m.p.h. line and DG line) = 1.64 cu.ft./min.

$$S/p_a = 0.28 \quad \text{and} \quad S = 16.88 \times 0.28 = 4.7 \text{ inches of mercury.}$$

From the altitude data in figures 8 and 15 the suction and air flow at 15,000 feet are 5 percent lower than the values computed above for given air speed.

While it is evident that altitude data on the performance of both the gyroscopic instrument and the venturi tube are required in order to determine accurately the performance of the combination at various altitudes, it is also evident that approximate predictions of performance which may be of considerable value may be made from sea-level data on the venturi tube together with data, either experimental or computed, on the suction air-flow characteristics of the gyroscopic instrument and tubing.

It should be noted in calculating performance that the air speed at the point at which the venturi tube is installed must be used. In installations where the tube is in the slipstream this will be considerably larger than the air speed of the airplane.

Complete data are not available on the single-throat venturi tube, so that no definite statement can be made as to the accuracy with which the sea-level data such as given in figure 7 gives the performance at various altitudes.

CONCLUSIONS

The results of the wind-tunnel and flight tests on the venturi tubes led to the following general conclusions:

1. For constant values of the ratio of suction to atmospheric pressure the air flow is approximately a linear function, independent of altitude for a double venturi tube, of the product of the indicated air speed and the square root of the ratio of standard air pressure to the atmospheric pressure.

2. For a given installation of an air-driven instrument connected to a venturi tube by means of tubing, the volume rate of air flow is approximately proportional to the product of indicated air speed and the square root of the ratio of a standard pressure to ambient air pressure. The ratio of the suction at the venturi inlet to the ambient air pressure is a constant approximately independent of altitude at a given air flow.

3. From the above it follows that an approximate prediction of the performance of a double venturi tube at any altitude may be made from data obtained at sea level. For a single venturi tube the prediction of performance is restricted to the relations given in paragraph (2) above.

4. The variation in the suction developed by individual tubes of the same design at a given air speed and induced air flow amounts to about 20 percent.

5. The drag is proportional to the impact pressure.

6. The effect produced by large angles of pitch and yaw on the performance of venturi tubes is negligible.

7. The apparent upper limit of suction with no induced air flow for a double venturi tube is approximately $\frac{2}{3}$ the atmospheric pressure.

8. The maximum efficiency of the single venturi tube is about 4 percent, that of the double venturi tube about 3 percent. The maximum efficiency at a given air speed occurs when the venturi tube is developing one-half the suction at no induced air flow and falls off at suction above and below this value.

9. Fairing the external surface of one venturi tube reduced the drag but also reduced the suction developed.

National Bureau of Standards,
Washington, D. C., October 1937.

REFERENCES

1. Toussaint, A., and Lepere, G.: Expériences sur l'ajutage de Venturi. Bull. de l'Institut Aerotechnique de l'Universite de Paris, 1913.
2. Piercy, N. A. V., and Mines, R.: On the Immersed Venturi with Special Reference to Its Use on Aircraft for Purposes of Power Transmission. R. & M. No. 364, British A.C.A., 1921.
3. Draper, C. S., and Spilhaus, A. F.: Power Supplies for Suction-Driven Gyroscopic Aircraft Instruments. A.S.M.E. Trans., vol. 56, no. 5, May 1934, pp. 289-294.
4. Crowley, J. W., Jr.: Investigation of Slipstream Velocity. T.R. No. 194, N.A.C.A., 1924.
5. Hersey, Mayo D., Hunt, Franklin L., and Eaton, Herbert N.: The Altitude Effect on Air Speed Indicators - Part I. T.R. No. 110, N.A.C.A., 1921.
6. Eaton, H. N., and MacNair, W. A.: The Altitude Effect on Air Speed Indicators - II. T.R. No. 156, N.A.C.A., 1922.
7. Beij, K. Hilding: Aircraft Speed Instruments. T.R. No. 420, N.A.C.A., 1932.
8. Peters, H.: Effect of Viscosity in Speed Measurements with Double-Throat Venturi Tubes. T.M. No. 633, N.A.C.A., 1931.

LEGENDS

Figures

1. Diagram of the single-throat venturi tube.
2. Single-throat venturi tube.
3. Diagram of the double-throat venturi tube.
4. Double-throat venturi tube.
5. Schematic diagram of installation in the wind tunnel: W.P., wall-plate manometer; S, suction manometer; F, flow manometer; B, drag balance; R, flow-regulating valve; O, calibrated orifice; P, tubular support; V, venturi tube.
6. Variation of suction with air flow at constant indicated air speed in wind-tunnel test of Sperry venturi tube S6. The air flow is reduced to that at the pressure at the venturi inlet. The room temperature ranged from 27.5° to 34° C., and the barometric pressure was 29.8 inches of mercury.
7. Performance at sea level (29.92 inches of mercury, $30^{\circ} \pm 5^{\circ}$ C.) of single venturi tube P3. Here p_a is the static pressure in the wind tunnel, S is the suction at the venturi inlet with reference to p_a , V_i is the indicated air speed, and p_s is the standard sea-level pressure (29.92 inches of mercury). Relation between air flow and $V_i p_s/p_a$ is given for the constant values of (S/p_a) indicated by the numbers on the curves.
8. Performance at sea level (29.92 inches of mercury, $30^{\circ} \pm 5^{\circ}$ C.) of double venturi tube S6. Here p_a is the atmospheric pressure in the wind tunnel, p_s is the standard sea-level pressure (29.92 inches of mercury), V_i is the indicated air speed, and S is the suction with reference to p_a . Relation between air flow and $V_i p_s/p_a$ is given for the constant values of S/p_a indicated by the numbers on the curves.

(Continued on p. 18.)

LEGENDS (Cont.)

Figures

- 8 (cont.) Lines H (horizon) and DG (directional gyro) show the performance for two typical installations, in which an air-driven gyroscopic instrument is connected by tubing.
9. Variation of suction with impact pressure for three single venturi tubes of similar design. Curves A show the suction for zero air flow. Curves B show the suction developed with an air flow of 1 cubic foot per minute measured at standard conditions.
10. Variation of suction with impact pressure for three double-venturi tubes of similar design. Curves A show the suction for zero air flow; curves B for an air flow of 2 cubic feet per minute at 29.92 inches of mercury and $30^{\circ} \pm 5^{\circ}$ C. Tube S7 is tube S6 cylindrically faired.
11. Effect of pitch on the suction developed by double-venturi tube S6 at a true air speed of 96 miles per hour. Air flows are those at atmospheric pressure.
12. Effect of yaw on the suction developed by double-venturi tube S6 at an air speed of 96 miles per hour. Air flows are those at atmospheric pressure.
13. The pressure distribution along tube S4, where p_1 is the static pressure at openings at points along the length of the outer tube and p_2 is the static pressure in the wind tunnel. Curve A was obtained at an air speed of 45 miles per hour and curve B, at 135 miles per hour.
14. Effect of the air flow in the line on the suction developed at three points on tube S4 at an air speed of 135 miles per hour. Curves L and S show the suction obtained at the throats of the outer and inner units, respectively; curve F, that at the suction inlet of the tube.

LEGENDS (Cont.)

Figures

15. Flight-test data on tube S6. The full lines show the flight-test data at 7,500 feet for the stated values of S/p_a , where S is the suction and p_a is the atmospheric pressure, both in inches of mercury. The dotted lines present the wind-tunnel data. The indicated air speed is V_i ; the standard sea-level pressure is p_s .
16. Data on suction obtained in a flight test and wind-tunnel tests at altitudes up to 15,000 feet. Curve A is for a single- and curve B for a double-venturi tube, both with zero air flow. Curve C is for the double tube with a volume air flow at the venturi inlet of 2 cubic feet per minute. The indicated air speed is V_i ; p_s and p_a are the standard sea-level and ambient air pressures, respectively, in centigrade degrees absolute.
17. The air flow induced by venturi tubes through a fixed combination of orifice and tubing during flight tests at altitudes up to 15,000 feet. Curve A is for single tube (P3); curve B, for double tube (S6).

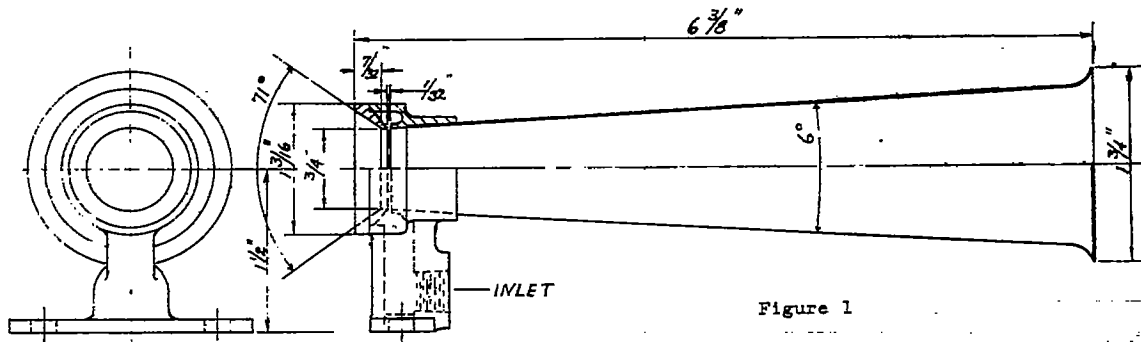

Figure 1

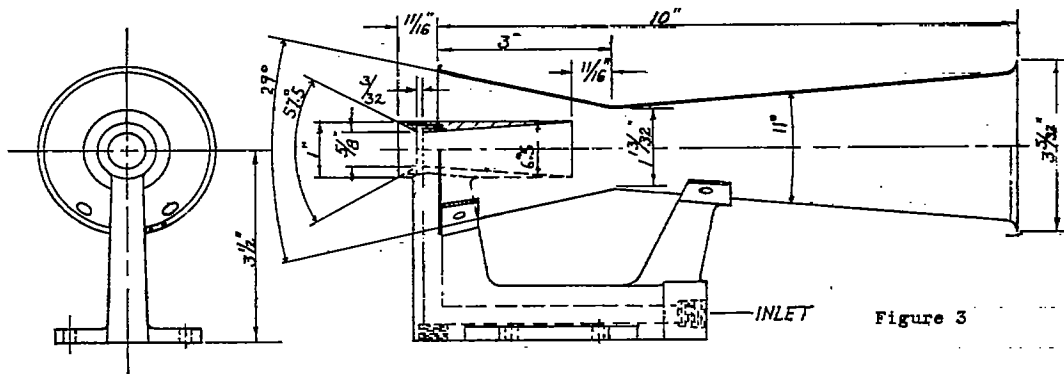

Figure 3

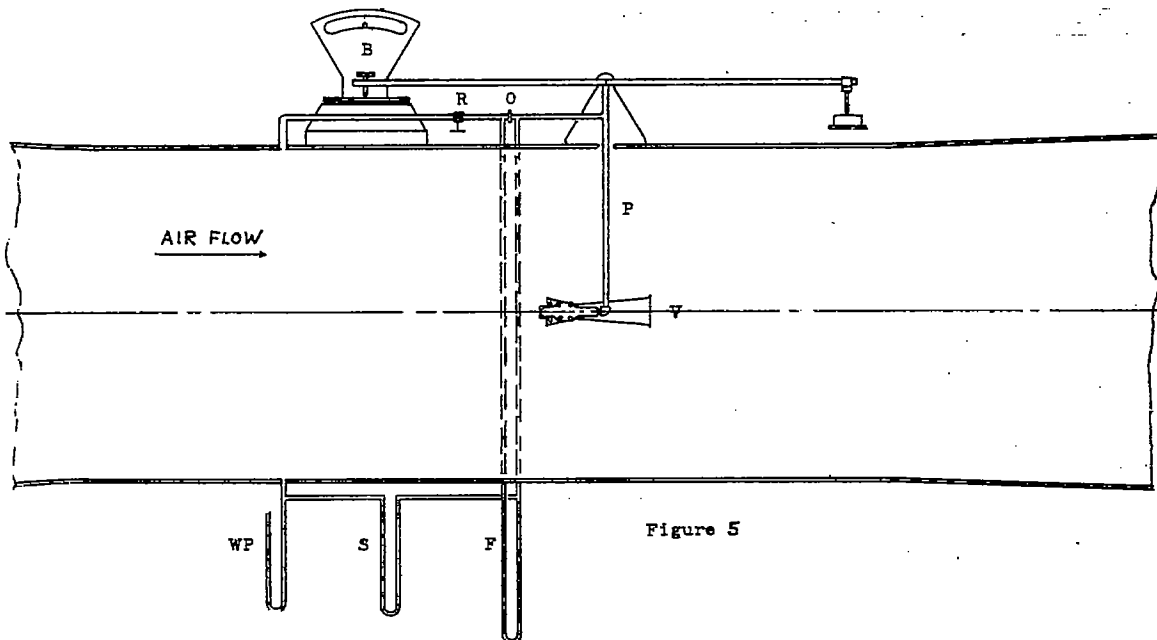
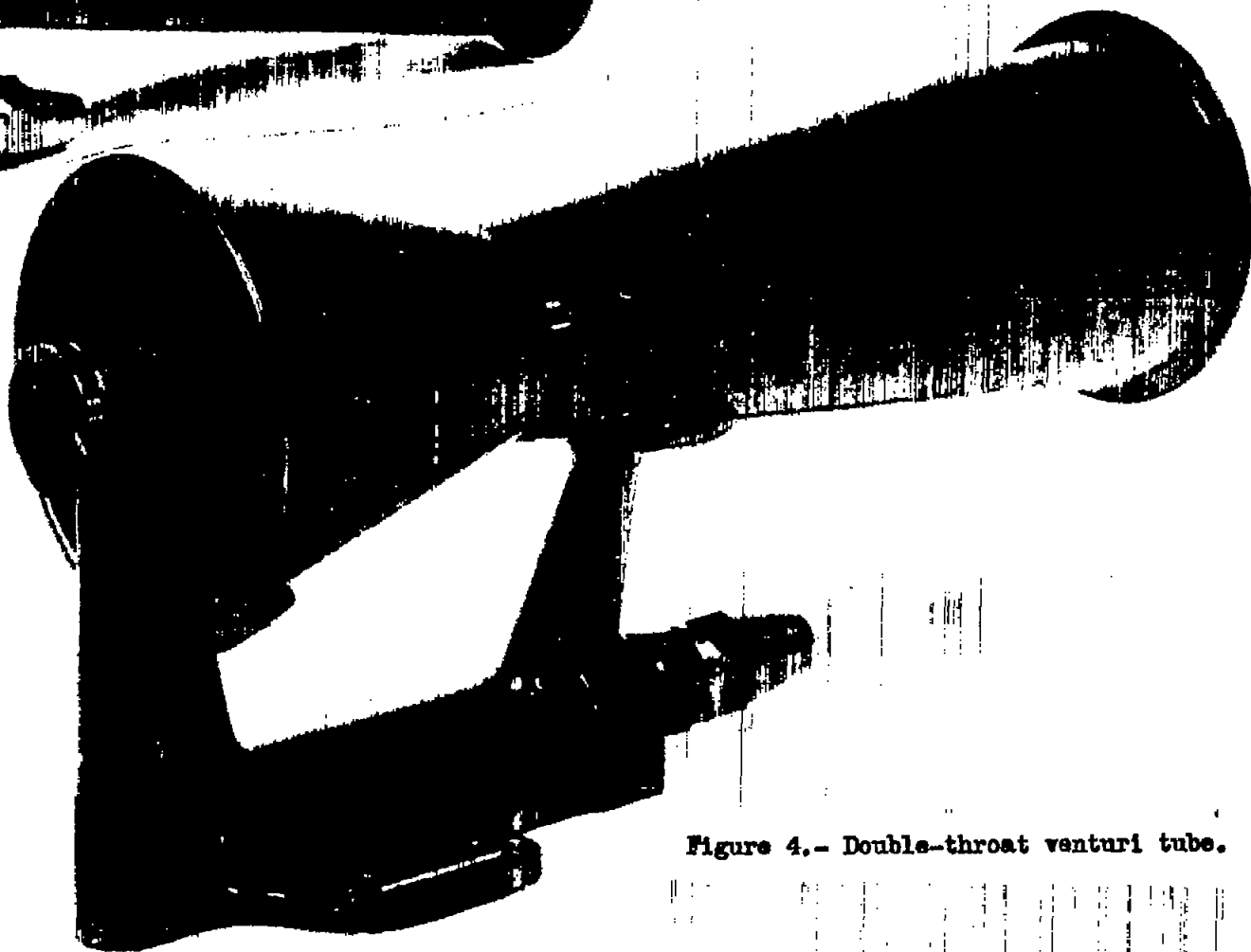

Figure 5

Figure 2.- Single-throat venturi tube.



Figure 4.- Double-throat venturi tube.



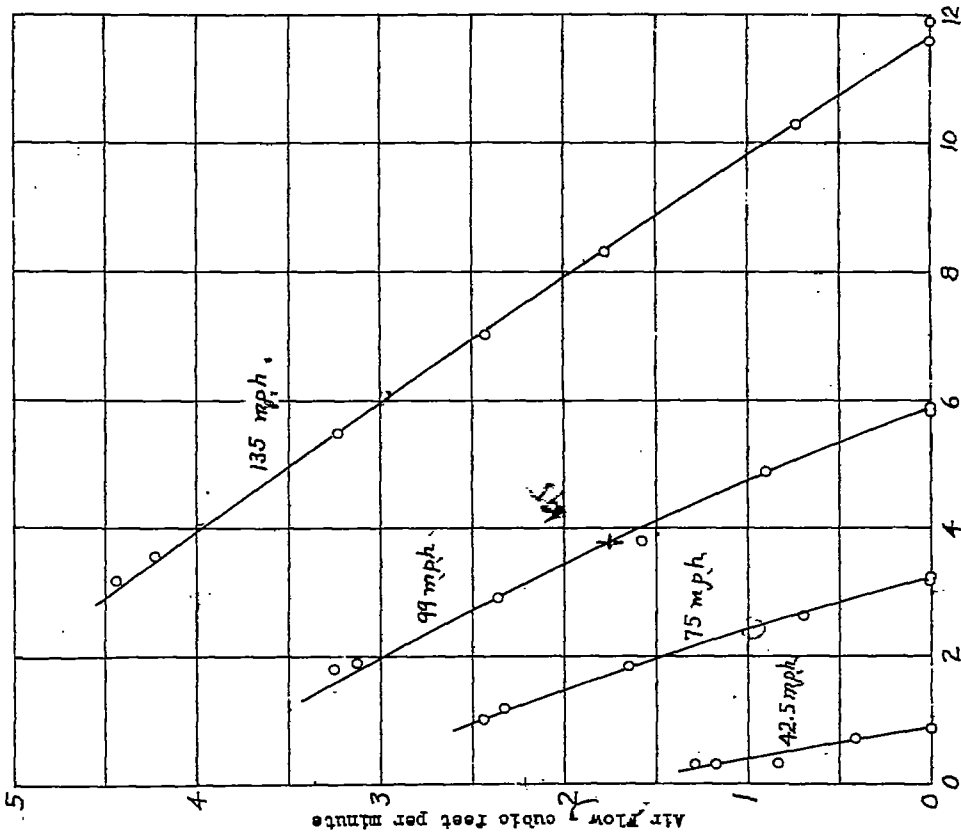

Suction at venturi inlet, inches of mercury
Figure 6.

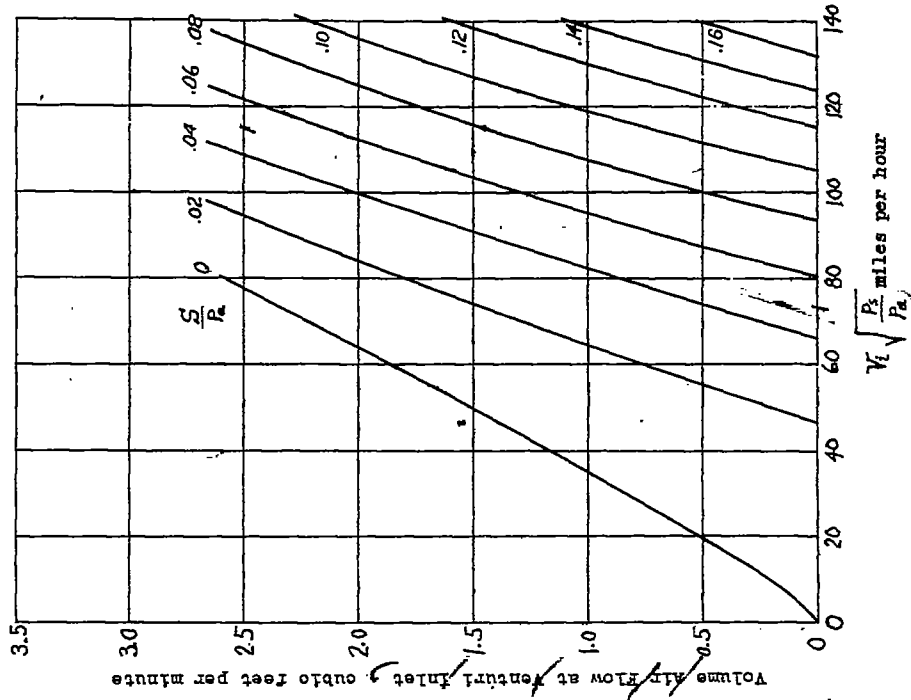

Figure 7.

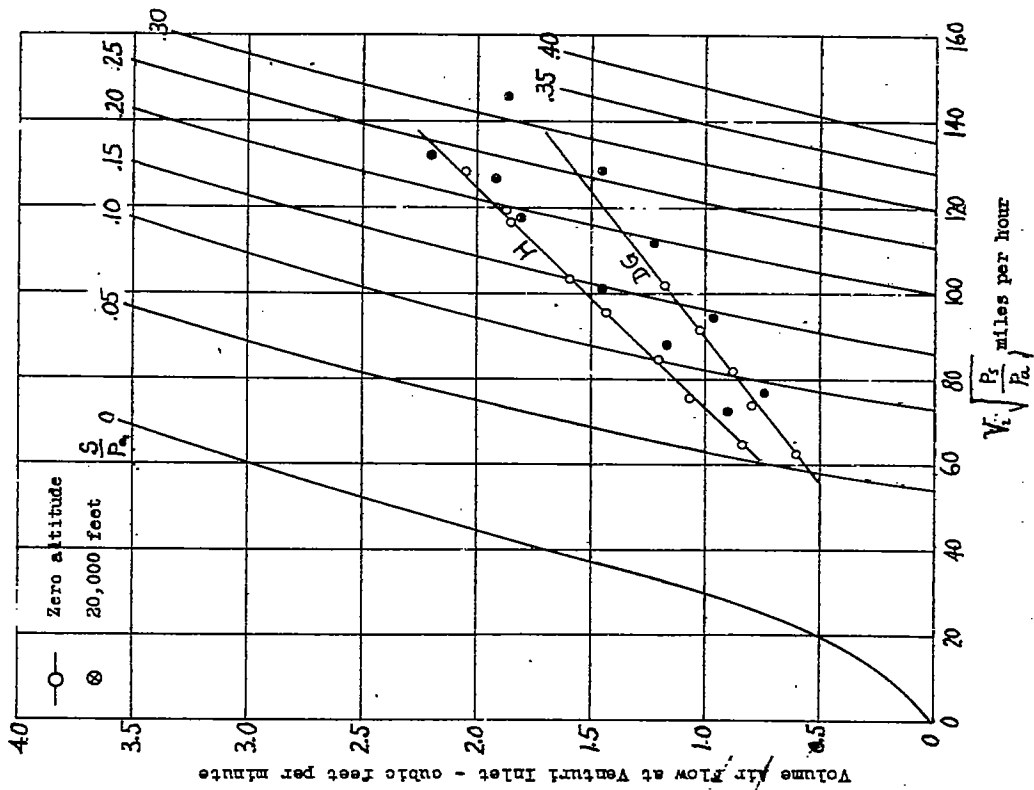
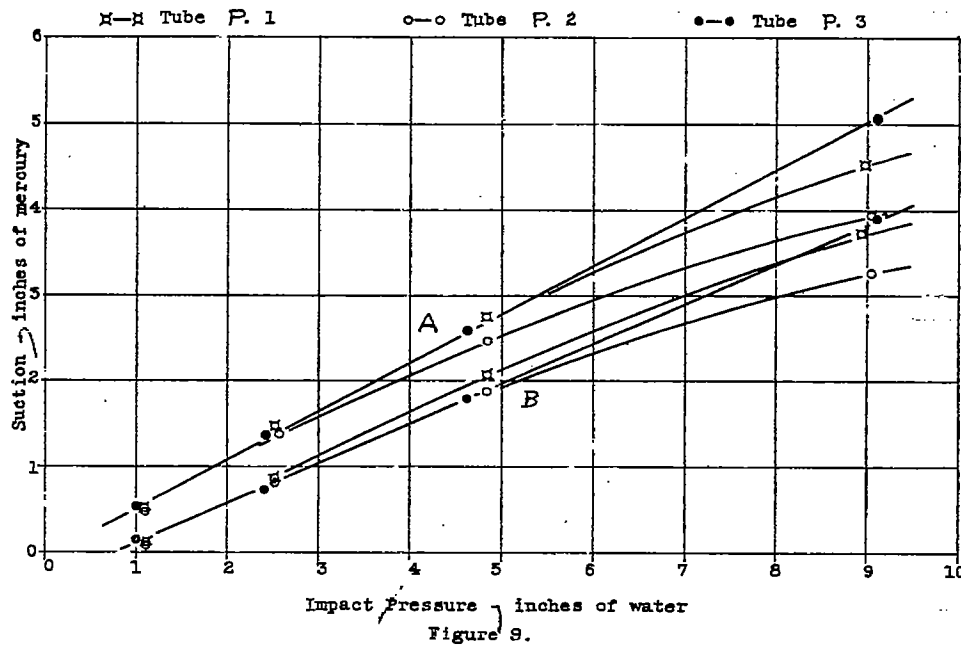
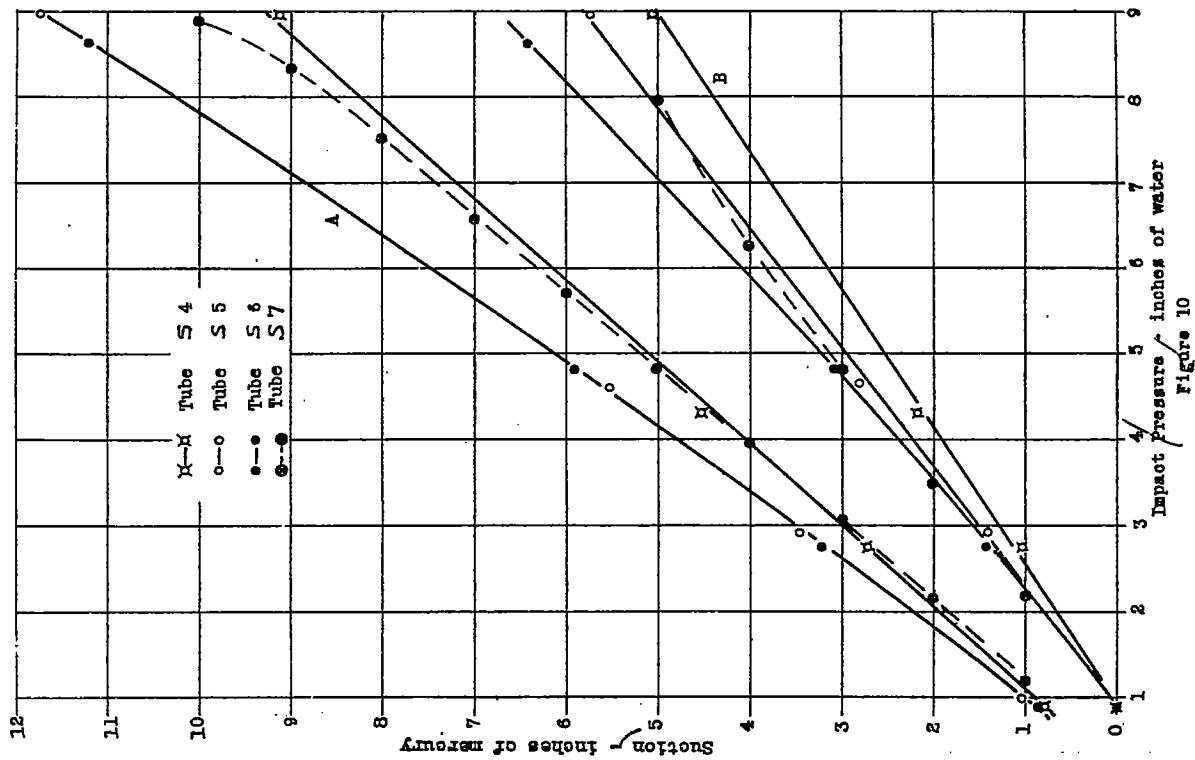
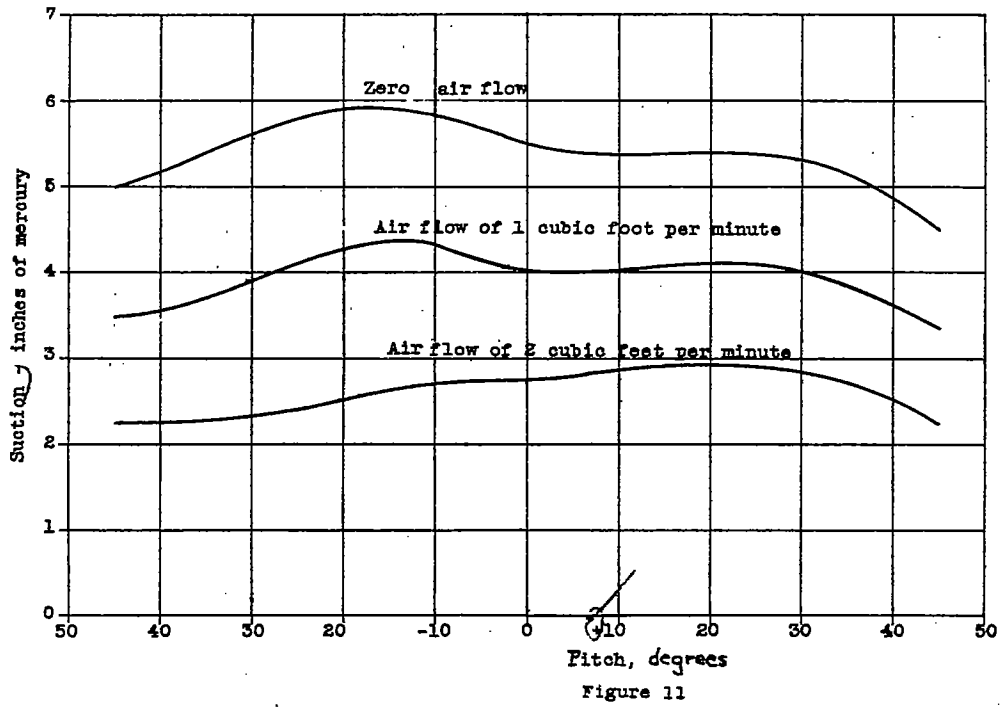
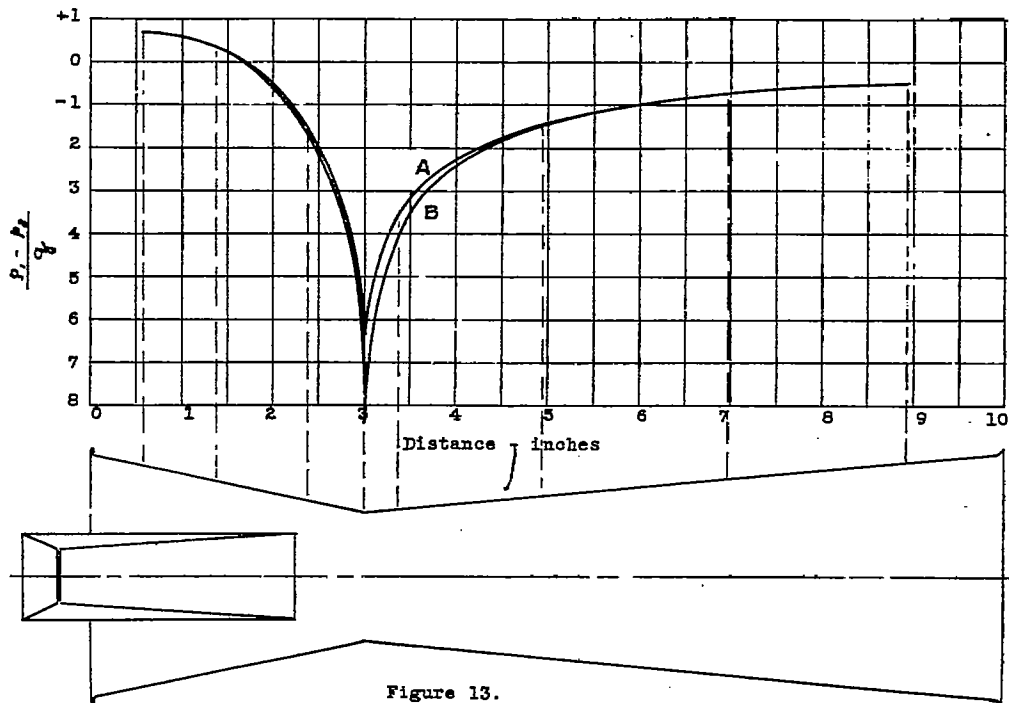
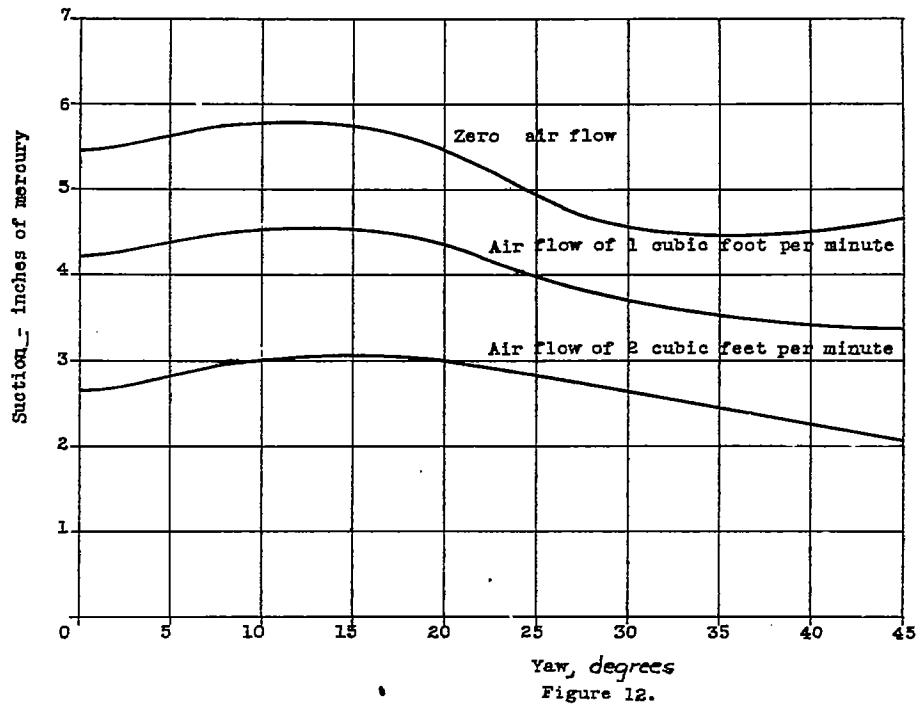

Figure 8.





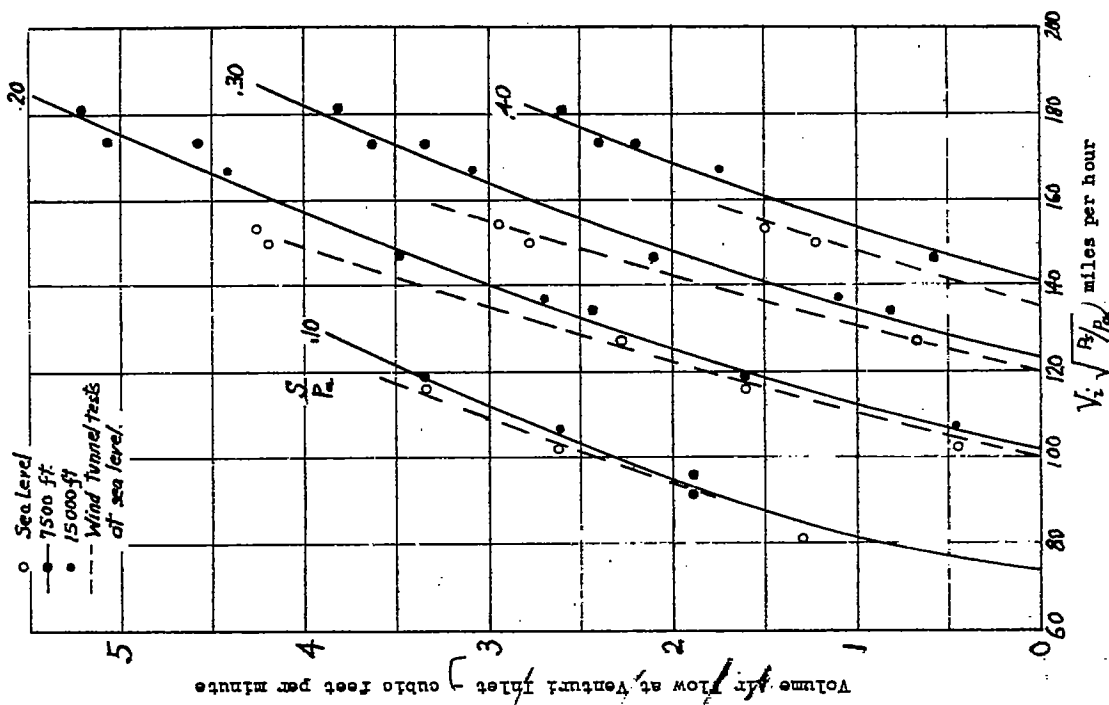

Figure 15.

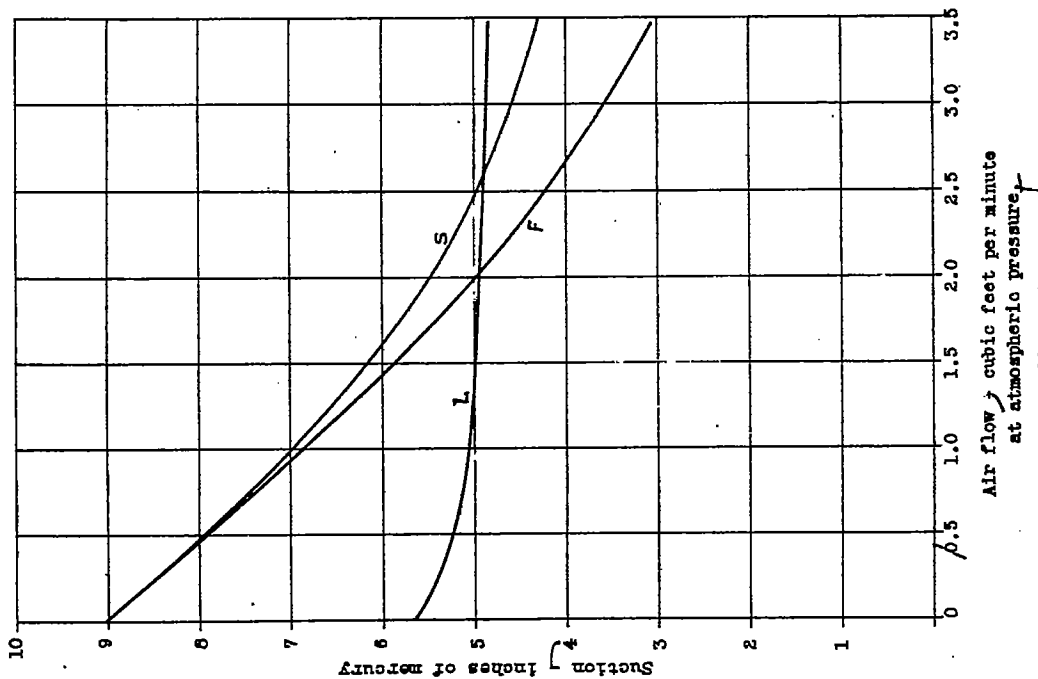

Figure 14.

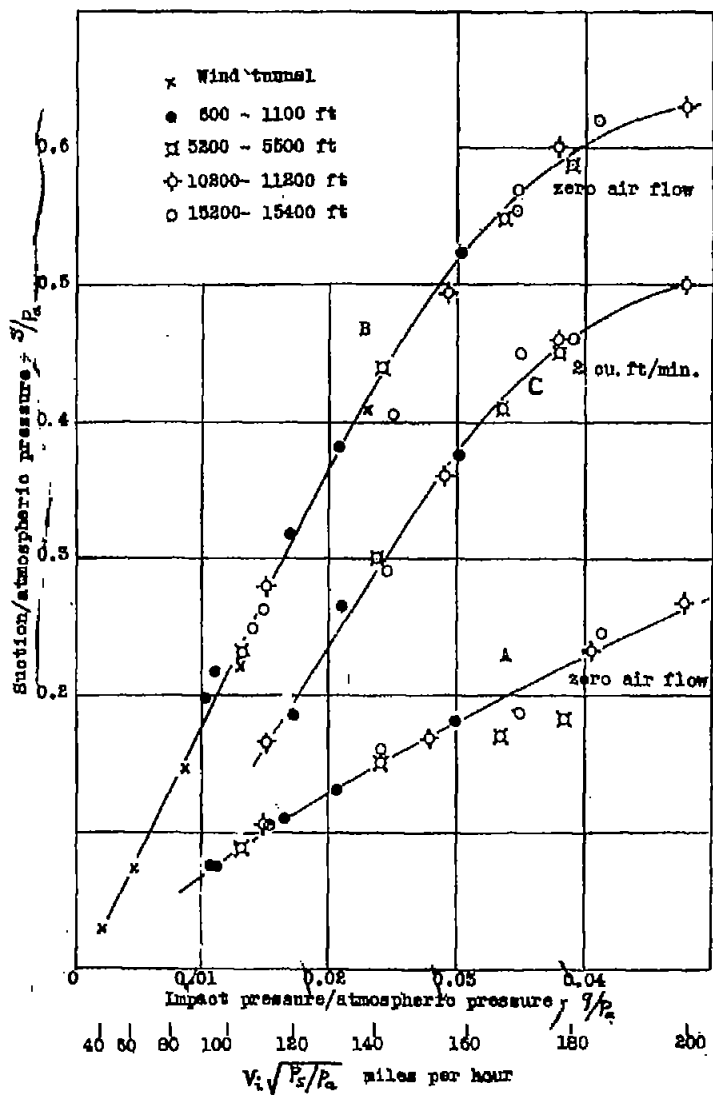

Figure 16.

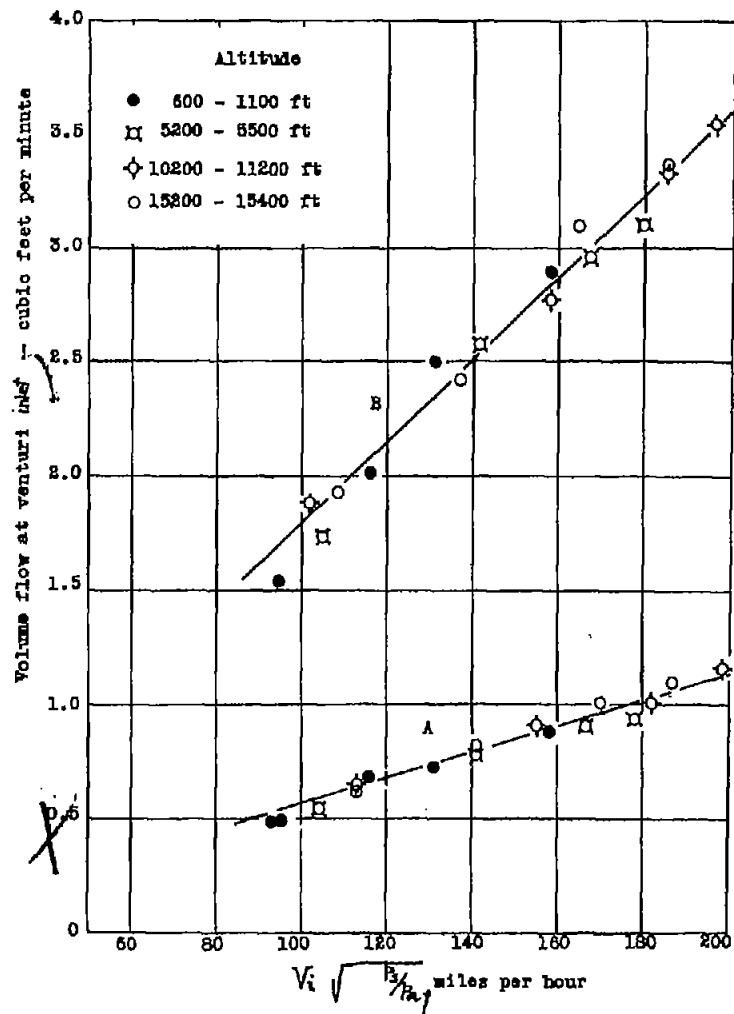

Figure 17.